



EN 54-4



0051
0051-CPR-0170
0051-CPR-0171



SmartLevel
SPS24060G
SPS24160G
Power supply station
Installation and programming manual



GameOver

inim[®]
ELECTRONICS

ISO 9001 Quality Management
certified by BSI with certificate number FM530352

Copyright

The information contained in this document is the sole property of INIM Electronics s.r.l. No part may be copied without written authorization from INIM Electronics s.r.l.

All rights reserved.

European directive compliance

This power station has been designed and developed to the highest standards of quality and performance implemented by INIM Electronics.

This power station must be installed in accordance with the instructions described in this manual and in compliance with the laws in force.

All power stations from the SmartLevel series are **EN54-4** compliant.

All power stations from the SmartLevel series, and all accessory items and special functions have IMQ Sistemi di Sicurezza certification, unless otherwise stated.

Declarations of performance, declarations of compliance and certificates relating to the products mentioned in this manual can be downloaded from the following website:

www.inim.biz/certifications

Table of contents

	Copyright	2
	European directive compliance	2
	Table of contents.....	3
Chapter 1	Overview.....	5
1.1	Application and use	5
1.2	The system parts and definitions	6
1.3	The SmartLevel power supply stations	6
Chapter 2	General information	7
2.1	Supplied documentation	7
2.2	Manual details	7
2.3	Operator qualifications - access levels	7
2.4	Intellectual property rights	7
2.5	Disclaimer	7
2.6	Recommendations	8
2.7	System test	8
2.8	Note to the installer	8
2.9	Technical support	8
2.10	Conventions	8
2.11	Manufacturer's name and address	9
2.12	CE Mark	9
2.13	Warranty	9
2.14	Safety laws	10
Chapter 3	Device management	11
3.1	Product handling and storage	11
3.2	Environmental conditions	11
3.3	Unpacking the device	11
Chapter 4	Functions and features	12
4.1	Controlling the Outputs	12
4.2	Controlling the outputs via the Inputs	13
4.3	How to use the power supply station	13
4.4	Protection circuit	14
Chapter 5	Technical description.....	15
5.1	Station	15
5.2	Internal devices	16
5.3	Technical specifications	17
Chapter 6	User interface	18
Chapter 7	Installation instructions	19
7.1	Wall mounting	19
7.2	RS485 BUS wiring	19
7.3	Connecting the output channels	20
7.4	Connecting the FAULT output	20
7.5	Connecting the mains power source	20
7.6	Connecting the batteries	21
7.7	Thermal probe	23
Chapter 8	Powering up the system	24
Chapter 9	Viewing the display screens	25
9.1	Presentation screen	25
9.2	Output status screen	25
9.3	Main menu	26
9.4	Faults screen	26

Chapter 10	Programming and maintenance from the panel	27
10.1	Programming operations	27
10.2	Direct Maintenance	28
10.3	Closing a Programming/Maintenance session	28
Chapter 11	Troubleshooting	29
11.1	Current faults list	29
11.2	“Output protection” fault	29
11.3	Battery faults	30
11.4	Other faults	30
Chapter 12	Maintenance	31
Appendix A	Order codes	32

Overview

Note: *The power supply stations described in this manual have been designed and developed to the highest standards of quality, reliability and performance. The components selected for this product will operate properly within their specifications when the environmental conditions outside the product enclosure comply with Class 3k5 (EN 60721-3-3).*

1.1 Application and use

The SmartLevel unit is a constituent part of your fire detection system and is capable of supplying power to the remote loads of the system. It supplies power to remote loads such as: fire-door magnets, sounders, emergency signs, linear smoke detectors.

Note: *The SmartLevel power supply station is EN54-4 compliant and specifically the amendment EN 54-4:1997/A2:2006 which includes a test regarding the internal resistance of the batteries.*

Main features:

- User interface comprising display, buttons and buzzer
- 3 controlled outputs
- fault relay
- direct connection to RS485 BUS

The SmartLevel can operate in stand-alone mode using the fault signaling output and on-board data, or combined mode using the RS485 BUS of an INIM Electronics fire detection system (refer to *Chapter 4 - Functions and features*).

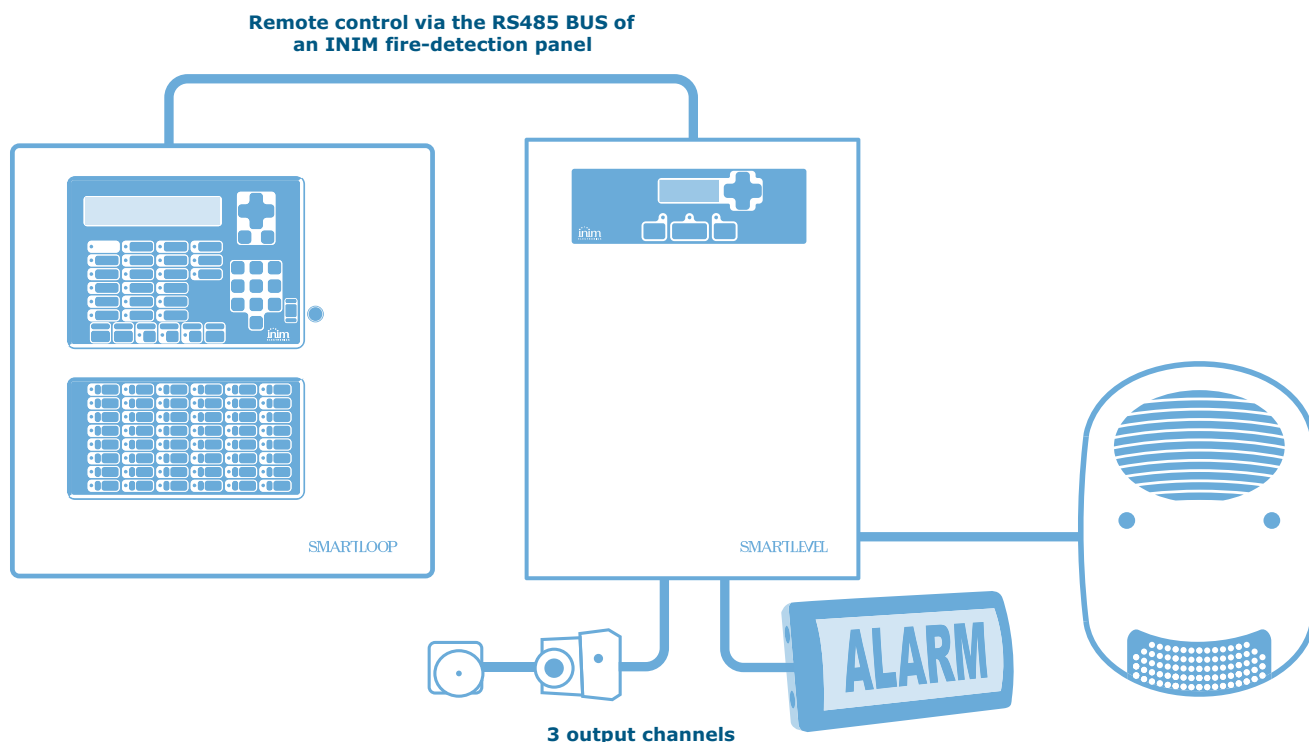

Figure 1 - Example of a typical application

1.2 The system parts and definitions

Switching power supply: this unit, starting from the mains power supply (230V~) it connects to, supplies the board with a 24V (27,6V $\overline{=}$) stabilized current capable of feeding the control panel and recharging the batteries. The power-supply module is located below the mother board and is EN54-4 compliant. the mains power supply (230V~) the primary power source of the system. Refer to *paragraph 5.2 Internal devices*.

Batteries: the secondary power source of the system. The power supply station enclosure houses two lead batteries @ 12V 7Ah (depending on the model) connected in series. The system monitors the battery status (efficiency and charge). A fault signal will be generated when voltage overload/underload or inefficient battery conditions occur (amendment A2). In the event of primary power failure (230V~), the batteries will take over automatically. If the problem persists for a long period thus causing the battery charge to drop below the minimum value required, they will be shutdown automatically in order to avoid damage. Refer to *paragraph 7.6 Connecting the batteries*.

Thermal probe: an accessory tool connected to the panel and attached to the battery pack. This device monitors the temperature of the battery pack and regulates the battery charge accordingly. Refer to *paragraph 7.7 Thermal probe*.

RS485 BUS: 4 wire BUS which allows the power supply station to be connected directly to INIM fire detection panels (SmartLoop, SmartLight and SmartLine). Four pole twisted cable must be used for all connections. Refer to *paragraph 7.2 RS485 BUS wiring*.

1.3 The SmartLevel power supply stations

Product models:

- SPS24060G - power-supply unit with internal 60W @ 27.6V $\overline{=}$ switching power-supply module and housing for 7Ah, 12V batteries
- SPS24140 - power-supply unit with internal 160W @ 27.6V $\overline{=}$ switching power-supply module and housing for 17Ah, 12V batteries

General information

2.1 Supplied documentation

The power supply station comes with a combined "Installation and Programming Manual" (this document). For further copies of the installation manual, please contact INIM electronics offices quoting the order number shown in *Appendix A Order codes*.

2.2 Manual details

- Title: SPS24060G and SPS24160G installation and programming manual
- Version: 1.00
- Installation and programming manual code: DCMIINIESPS24G
- Addresses: installer, technicians

2.3 Operator qualifications - access levels

The SmartLevel power supply station has been especially designed to comply with EN-54-4 (including the provisions of EN 54-4:1997/A2:2006). User Access

Level 1: Building occupants

Using the graphic screens, building occupants can view the status of the outputs and the output voltage. Furthermore, they can view the Events Log, silence the power-supply buzzer, test the LEDs and reset the power supply station.

Level 3: Authorized technicians appointed by the Installer company.

These technicians can, by means of the necessary tools, remove the frontplate of the power supply station. They can insert the respective jumpers in order to access and carry out programming and maintenance. Processing is inhibited during programming sessions, therefore, the device will be unable to generate any signals whatsoever.

Level 4: Technicians employed by the Manufacturer (INIM Electronics s.r.l.).

The manufacturer company technicians can, by means of special tools, repair or replace the control panel components.

Note: *This manual is for Authorized technicians (Level 3), however, it also describes some information regarding the end user (level 1).*

2.4 Intellectual property rights

The information contained in this document is private property. All rights reserved.

This document must not be reproduced, either totally or in part, without the prior written consent of INIM Electronics, and refers to the devices specified in *paragraph 2.12 CE Mark*.

2.5 Disclaimer

INIM Electronics s.r.l. shall not be responsible for damage arising from improper application or use.

Only qualified personnel (refer to Terminology) should touch this device. Installation must be carried out strictly in accordance with the instructions described herein, and in compliance with the local fire code in force.

2.6 Recommendations

INIM Electronics recommends that the entire system be checked completely at regular intervals (refer to *paragraph 2.7 System test*).

2.7 System test

This system has been designed to provide the highest standards of reliability and performance. Malfunction of any of the system devices may cause the system to be incapable of reaching the intended levels of performance. Most problems which prevent the system from operating as intended can be found by regular testing and maintenance of the system devices (refer to *Chapter 12 - Maintenance*).

2.8 Note to the installer

In order to provide adequate protection and instructions for correct use of the apparatus, you (the installer) must be fully aware of the regulations and operating procedures of firefighting. As the only individual in contact with system users, it is your responsibility to instruct them on how to use this device properly.

2.9 Technical support

Our professional engineers are readily available to assist you. If you require help, call us and you will be put through to a person capable of answering your questions and providing you with the service you need.

2.10 Conventions

2.10.1 Terminology

- **Power supply unit:** refers to the device defined in *paragraph 2.12 CE Mark*.
- **Left, right, behind, above, below:** refer to the directions as seen by the operator in front of the mounted device.
- **Qualified personnel:** those persons whose training, expertise and knowledge of the laws and bylaws regarding service conditions and the prevention of accidents, are able to identify and avoid all possible situations of danger.
- **Press:** click on a video button, or press a key on the panel keypad.

2.10.2 Graphic conventions

Following are the graphic conventions used in the text. For a description of the graphic conventions relating to the interface, refer to *Chapter 6 - User interface*.

Conventions	Example	Description
<i>Text in Italics</i>	Refer to <i>paragraph 2.10.2 Graphic conventions</i>	Text in italics: indicates the title of a chapter, section, paragraph, table or figure in this manual or other published reference.
[uppercase letter]	[A]	Representation of a part of the system or video object.
BUTTON	Ok/Esc	computer or control panel keys.

Note: *The detached notes contain important information about the text.*

Attention: **The attention prompts indicate that total or partial disregard of the procedure could damage the connected devices.**

Danger: **The danger warnings indicate that total or partial disregard of the procedure could injure the operator or persons in the vicinity.**

2.11 Manufacturer's name and address

INIM ELECTRONICS S.R.L.

Via Fosso Antico snc - Fraz. Centobuchi

63076 Montepandone (AP) - Italy

Tel: +39 0735 70 50 07

Fax: +39 0735 70 49 12

info@inim.biz - www.inim.biz

2.12 CE Mark

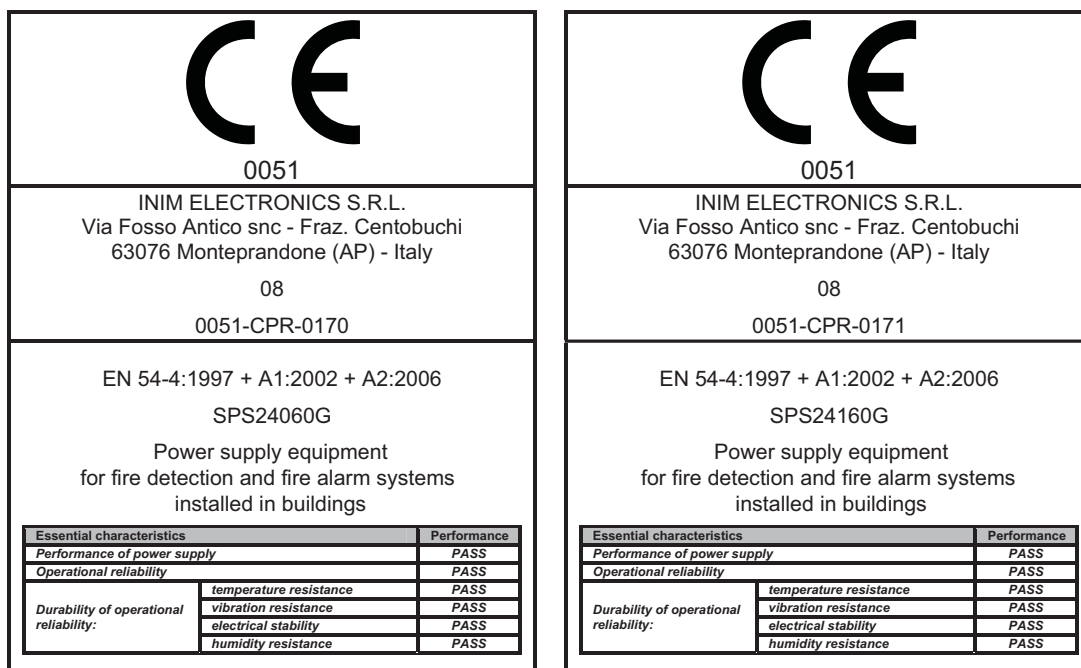

Figure 2 - Certifications for SmartLevel power stations

Declarations of performance, declarations of compliance and certificates relating to the products mentioned in this manual can be downloaded from the following website:

www.inim.biz/certifications

2.13 Warranty

INIM Electronics s.r.l. warrants that for a period of 24 months from the date of commissioning, the product shall be free of defects in materials and workmanship. The warranty applies only to defects in parts and workmanship relating to normal use. It does not cover:

- Improper use or negligence
- Damage caused by fire, flood, wind or lightning
- Vandalism
- Fair wear and tear

INIM Electronics s.r.l. shall, at its option, repair or replace any defective products. Improper use, that is, use for purposes other than those mentioned in this manual will void the warranty. For the full details and conditions regarding the warranty, refer to the purchase order.

2.14 Safety laws

The aim of the instructions in this section is to ensure that the device is installed and handled properly. It is assumed that anyone who handles this apparatus is familiar with the contents of this chapter.

2.14.1 Compliancy

The SmartLevel power supply station has been especially designed and manufactured to comply with EN 54-4 *Fire detection and signaling systems - Power supply devices* and the amendment *EN54-4:1997/A2:2006*.

2.14.2 Managing electronic devices

The normal motions of any person may generate electrostatic potential of thousands of volts. Discharge of this current through semiconductor devices during handling may cause serious damage which although may not be immediately evident may reduce the reliability of the circuits.

If located in their housings, the electronic circuits of INIM Electronics products are highly immune to electrostatic discharge.

- Do not expose the circuits to damage by removing the modules unnecessarily from their housings.
- When removing or handling the boards, hold the board edges only.
- Do not touch the electronic components, the printed circuits or the metal parts of the connectors.
- Do not hand the board to another person without first ensuring that both of you have the same electrostatic potential. This can be achieved by simply shaking hands.
- Place the board on an anti-static surface or a conductor surface with the same potential.

Further information regarding procedures relating to safety when working with electronic devices can be found in EN 61340-5-1 e CLC/TR 61340-5-2.

2.14.3 Setting up the system

In order to provide adequate protection and instructions for proper use, security professionals (Installers and maintenance technicians) must be familiar with the operating procedure of this device.

Please read the instructions carefully before installing and setting up this product.

Before first power-up, be sure that the earth connection has been completed properly on the respective terminal.

The recommended minimum wire cross section for the earth connection is 2.5 mm^2 , unless otherwise stated in accessory documentation.

2.14.4 Replacement and disposal of used devices

Replacement

When replacing obsolete devices, disconnect the devices concerned then complete the connections of the new devices in compliance with the instructions printed on the respective leaflets.

In order to avoid short-circuits, take all the necessary precautions when removing used batteries.

Disposal

Do not burn used electronic devices, or allow them to pollute the environment (countryside, rivers, etc.). Electronic devices must be disposed of in a safe environment-friendly way.

When disposing used devices or batteries, contact your local municipal offices for information regarding their disposal.

Device management

3.1 Product handling and storage

This device is safely packed inside a cardboard box, however, care must be taken to avoid accidental damage during handling. Cartons/boxes should be placed in such a way as to avoid knocks and falls, and special care must be taken to protect the devices from extreme heat and/or cold.

3.2 Environmental conditions

Temperature limits:

- -10° / +55°C for transport and storage
- -5° / +40°C operating temperature

3.3 Unpacking the device

On receipt the goods must be unpacked with care. All waste packaging materials must be disposed of in compliance with the local laws and bylaws in force.

The metal enclosure of the device is packed carefully inside the cardboard box.

Note: *The lead batteries are not included. Be sure you have the batteries on hand before starting.*

When you remove the four screws and metal-frontplate, you will find:

- The SmartLevel motherboard, mounted on a plastic support which bridges the two sides of the metal enclosure.
- Power supply module located under the plastic support. The power-supply module is already connected to the SmartLevel motherboard.
- Thermal probe connected to the power-supply module, for battery-charge optimization.
- A plastic bag containing the battery and earth connection wires.

Functions and features

4.1 Controlling the Outputs

The power-supply outputs can be controlled locally, via the on-board inputs B1, B2 and B3 or remotely, via the RS485 BUS of an INIM Fire detection panel.

The outputs follow the "OR" logic of the status of their command inputs, refer to the following Table.

Command input	Remote command via RS485 BUS	Output
Open (standby)	OFF (default)	Standby
Open (standby)	ON	Active
Closed (active - default)	OFF (default)	Active
Closed (active - default)	ON	Active

You can define the standby status of each output using the Booster option in the programming menu (refer to *paragraph 10.1.1 Setting up the Booster parameters*):

1. Standby-ON

Under these circumstances, there will be 24V $\overline{\text{---}}$ (ON) across the terminal when the output is in standby status and 0V $\overline{\text{---}}$ (OFF) when the output activates. This is the setting at default.

2. Standby-OFF

Under these circumstances, there will be 0V $\overline{\text{---}}$ (ON) across the terminal when the output is in standby status and 24V $\overline{\text{---}}$ (OFF) when the output activates.

You can also classify the output as monostable, in this way, it will be possible to define the output activation time (ON Time). Once the set activation time expires, the output will restore to standby status automatically but cannot be re-activated until the cause of activation clears.

If the activation time is not defined ("--"), the output will restore to standby status only when the cause of activation clears.

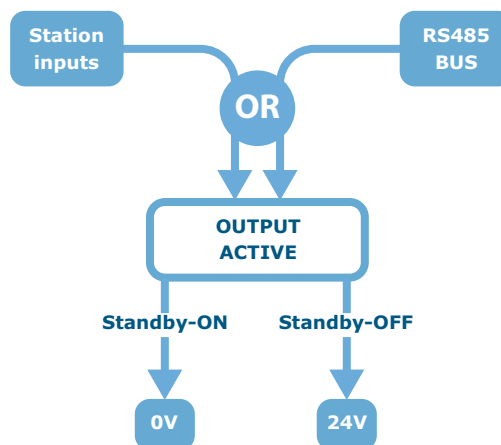

Figure 3 - Output activation

Note: *The outputs will be blocked automatically when you insert the programming jumper.*

4.2 Controlling the outputs via the Inputs

Outputs OUT1, OUT2 and OUT3 are controlled respectively by inputs B1, B2 and B3.

The inputs are normally open (standby status), therefore, activation occurs when they are short-circuited to GND.

4.3 How to use the power supply station

4.3.1 Stand-alone

In this operating mode the power-supply station is self-controlled, therefore, the outputs are managed via the inputs. Fault conditions are signaled through the fault relay (FAULT output), which switches from standby status to active status when faults occur.

4.3.2 Combined with an INIM Fire detection panel

There are two ways of connecting power supplies to INIM Fire detection panels, via:

- Loop connection
- RS485 BUS connection

Loop connection

This connection method allows the fire-detection panel to manage the power-supply outputs and fault signals. The power-supply stations must be connected to the loop via one or more input/output modules located inside the power supply station enclosure. The details of fault events can be viewed on the power supply station display.

The following wiring diagram shows a loop connection using an input/output module from INIM Electronics s.r.l. ENEA series:

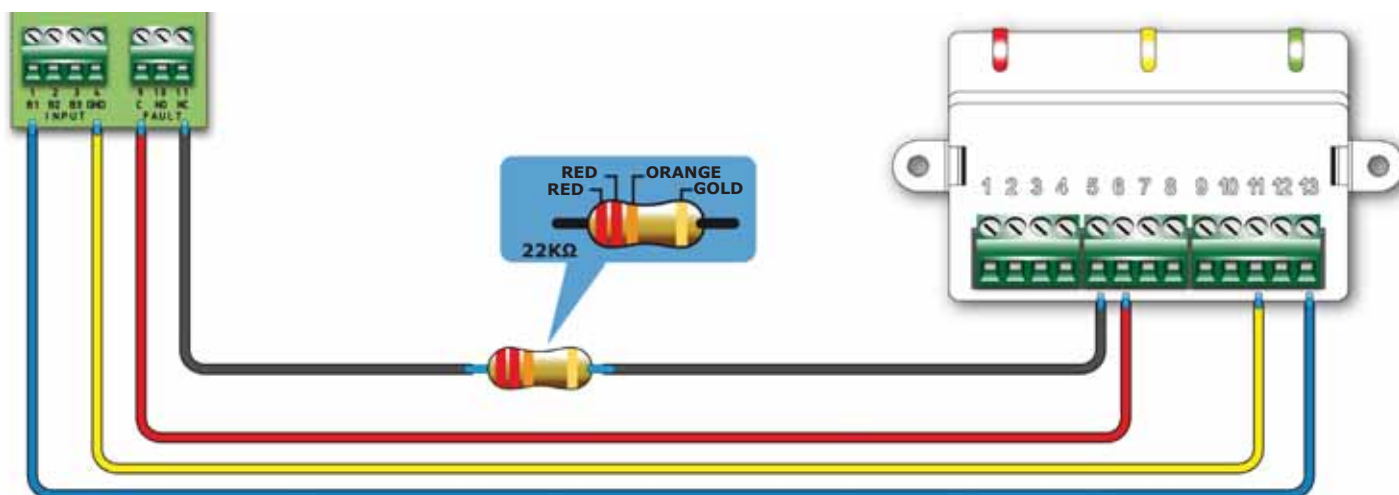

Figure 4 - Wiring diagram of a loop connection using a EM312SR module

Connecting to an RS485 BUS

SmartLevel power-supply units are equipped with terminals which allow direct connection to the RS485 BUS of INIM fire detection panels. If any other devices are connected to the RS485 BUS, the power supplies must be connected in parallel to them. The INIM fire detection panel will communicate with the power supplies using a noise-immune communication protocol.

This connection method is designed to keep the control panel voltage isolated from the power-supply station voltage.

The INIM fire-detection panel can enroll the power supply station, control its outputs as described in the Table in *paragraph 4.1 Controlling the Outputs* and monitor its status (output and fault status). For details regarding the respective wiring refer to *paragraph 7.2 RS485 BUS wiring*.

Note:

If the power supply station is the last device on the BUS, you must insert the jumper JP3 in the EOL position.

4.4 Protection circuit

The outputs are protected against short-circuit and overload by a protection circuit (circuit breaker) which operates in the same way as a fuse.

If the protection circuit intervenes, the power supply station will signal the fault and protect the interrupted line before making three attempts to re-activate it.

- If the fault condition (overload) clears, the output channel voltage will restore to 24V (ON).
- If the fault condition is still present after the third attempt, the power supply station will leave the output at 0V (ALERT).

The three attempts to re-activate the line will be carried out at 2, 5 and 10 seconds from the start of the fault.

In the event of a fault, follow the procedure described in *paragraph 11.2 "Output protection" fault*.



Figure 5 - OUT1 channel protected by fuse

Note: *The protection circuit will continue to operate even when the PROG jumper is inserted.*

Technical description

5.1 Station

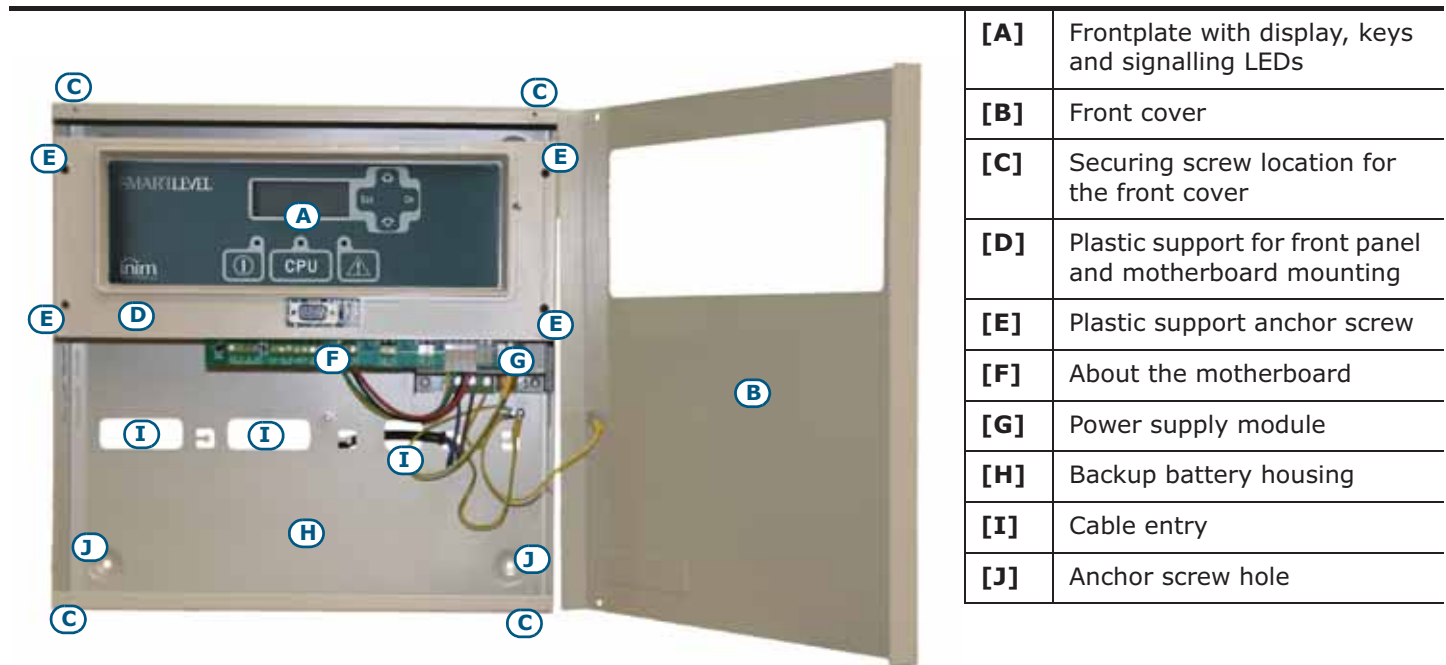

Figure 6 - Inside SPS24060G

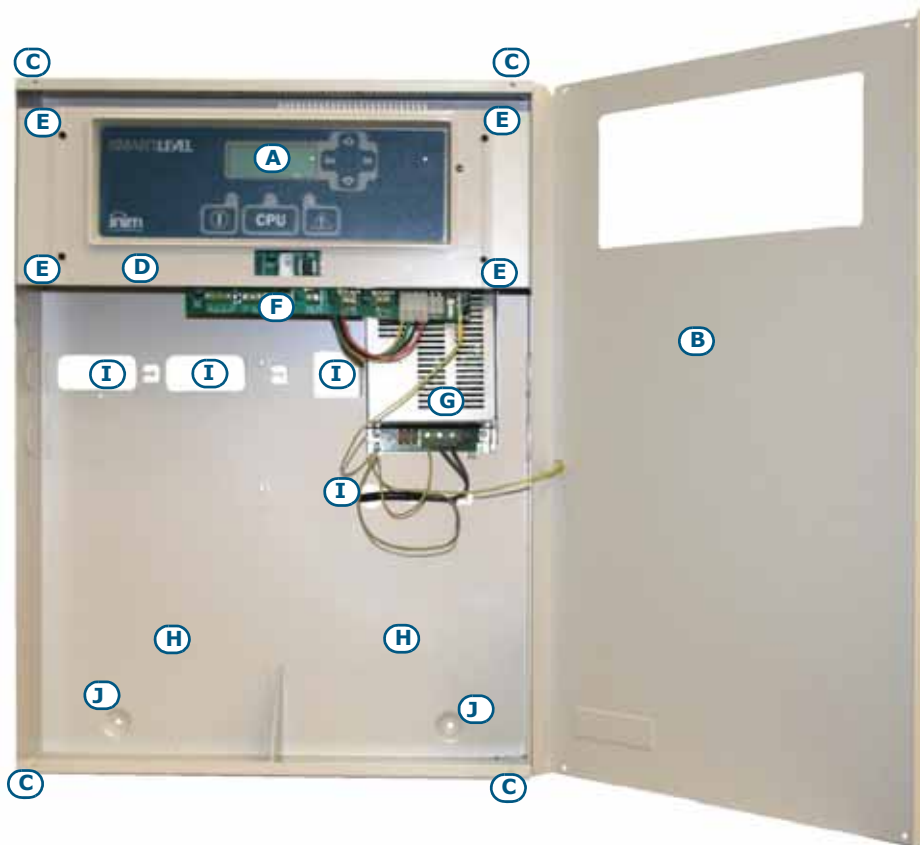

Figure 7 - Inside SPS24160G

5.2 Internal devices

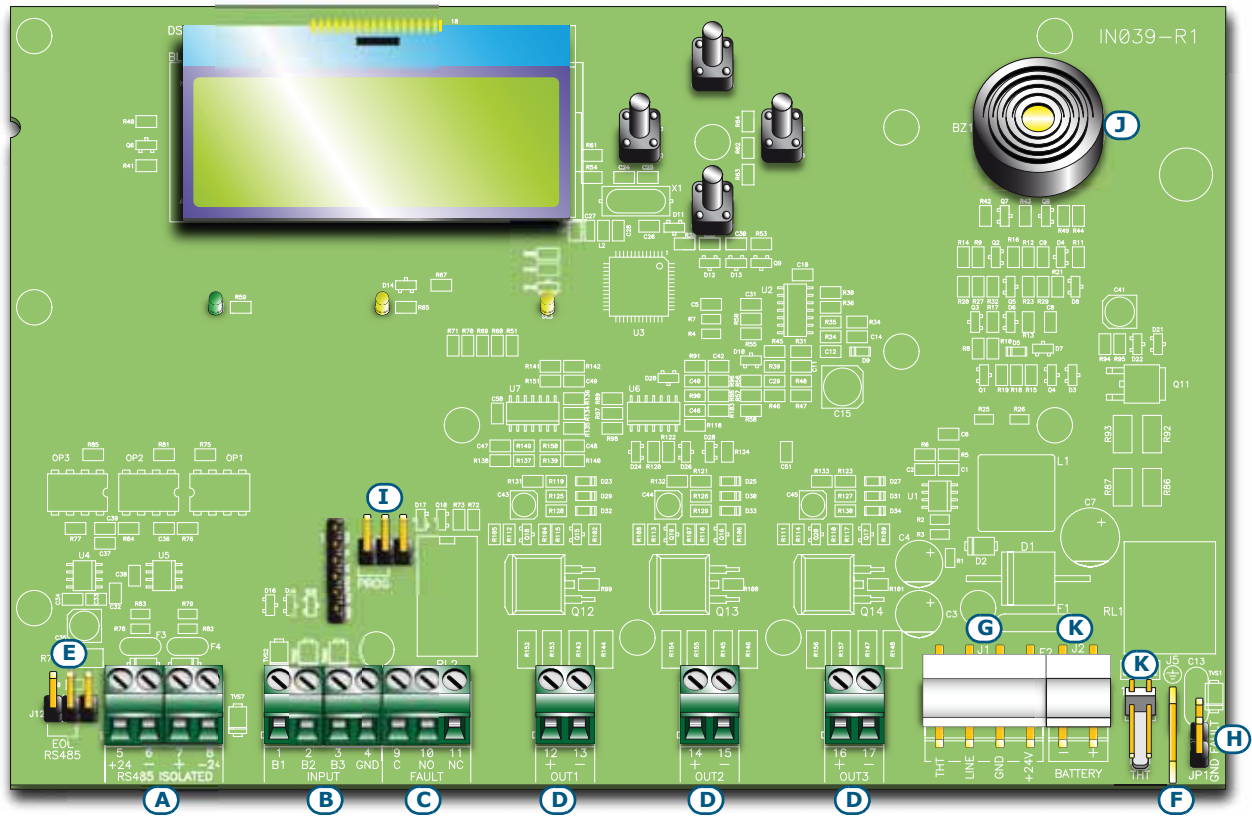

Figure 8 - The SmartLevel motherboard

Main components

[A]	RS485 ISOLATED	RS485 BUS terminals for direct connection to INIM Fire detection panels
[B]	INPUT	Input terminals (B1, B2, B3)
[C]	FAULT	Voltage free fault relay contacts
[D]	OUT1, OUT2, OUT3	Output channels terminals
[E]		RS485 BUS EOL jumper
[F]		Connector for the earth wire of the power supply module
[G]		Power-supply module connector
[H]		Earth-fault bypass jumper—if the jumper is removed, earth faults will not be signaled.
[I]		Programming jumper (PROG)
[J]		Buzzer
[K]		Reserved connectors DO NOT USE

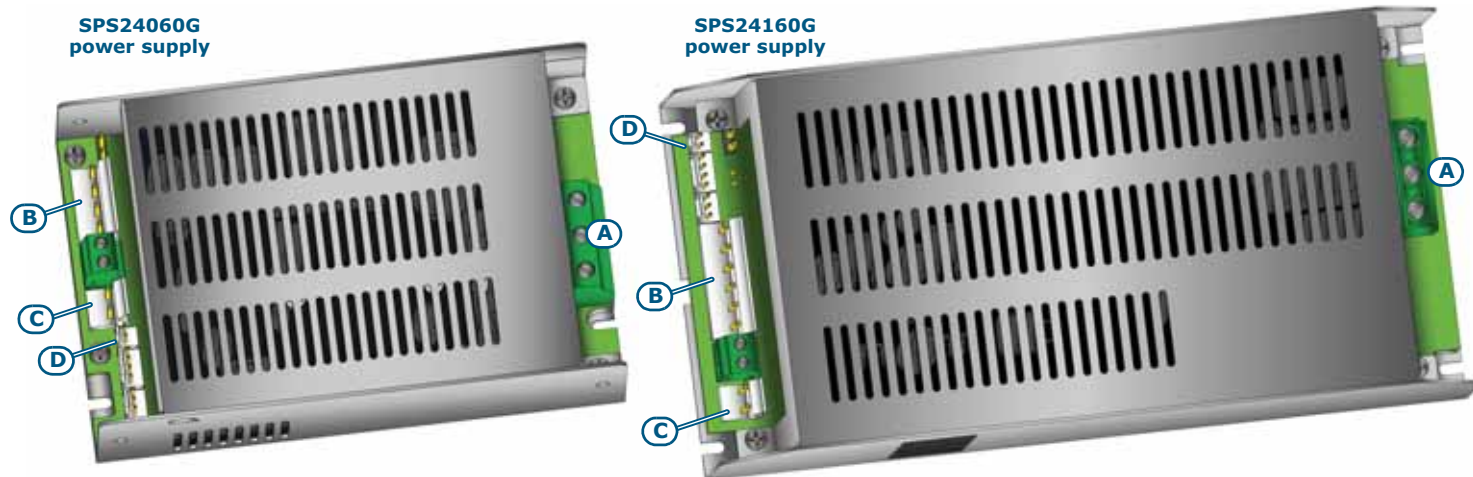

Figure 9 - Switching power supply

The switching power supply is attached to the backplate of the metal enclosure. The power supply type depends on the station model.

	SPS24060G	SPS24160G
	Mains input terminal board	
[A]		
[B]	SmartLevel mother board connector	
[C]	Battery connector	
[D]	Thermal probe connector	

Note: *INIM s.r.l. reserves the right to change, replace, in part or entirely, the components not strictly relating to the installation procedure described in Chapter 7 - Installation instructions.*

5.3 Technical specifications

Specification	SPS24060G	SPS24160G
AC power	230 V \sim (-15% / +10%) 50/60 Hz	
Maximum current draw 230V	0.5 A	1.1 A
Nominal output voltage	27.6 V ---	
Maximum output current	2.1 A	5.2 A
$I_{\text{max. a}}$	1.5 A	4 A
$I_{\text{max. b}}$	1.5 A	4 A
Maximum battery current emission during primary power failure	1.5 A	4 A
Maximum current for external loads and accessory devices	1.46 A	3.96 A
Maximum battery-charge current	0.6 A	1.2 A
Minimum current (I_{min})	40 mA	
Battery specifications	2 x 12V, 7 Ah	2 x 12V, 17 Ah 2 x 12 V/7 Ah YUASA NP-12 FR or similar with case flame class UL94-V2 or higher
Maximum internal resistance of the batteries ($R_{i \text{ max}}$)	2.7 Ohm	1 Ohm
Output voltage	from 18 to 27.6V ---	
Battery shutdown tension	19V ---	
Internal fuse of switching power supply module	T 3.15A 250V	
Maximum output current ripple	1%	
Operating temperature	from -5°C to 40°C	
Isolation class	I	
Enclosure protection class (EN 60529)	IP30	
Dimensions	325 x 325 x 80 mm	497 x 380 x 87 mm
Weight	2.8 Kg	6 Kg

Chapter 6

User interface

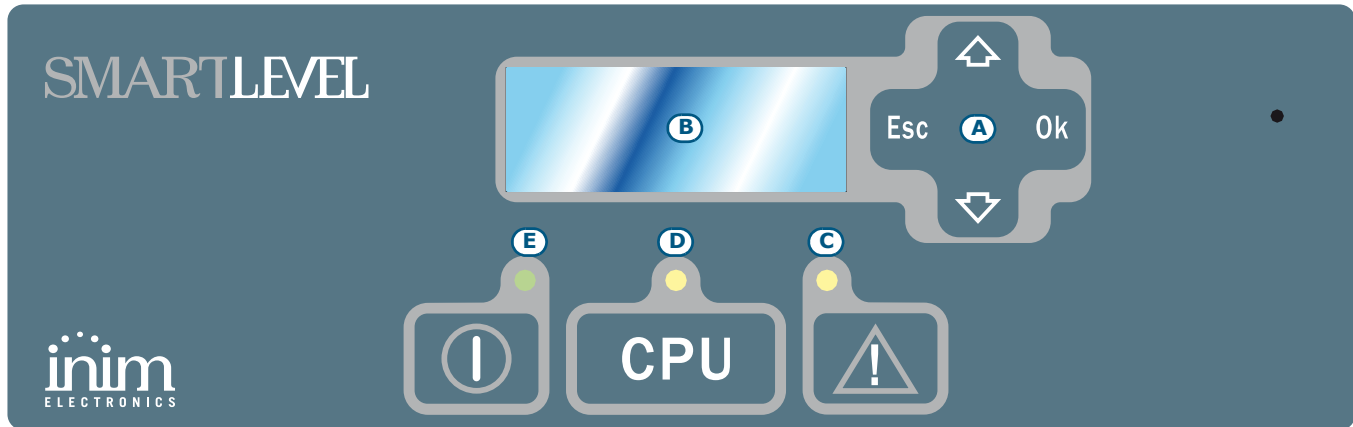

Figure 10 - Front panel

	Keys	
[A]	▲/▼/Ok/Esc	To be used to navigate through the menus on the display. The effect these keys have during programming depends on the specific field. See <i>Chapter 10 - Programming and maintenance from the panel</i> .

	LED	If On solid:	ON blinking:	Note
[B]	LCD display			See <i>Chapter 9 - Viewing the display screens</i> .
[C]	FAULT (yellow)	Indicates an active system fault condition. The display will provide the fault details.	Indicates memory of a cleared fault event. To view the restored fault condition details, consult the events log using the main menu (level 1).	To restore the fault memory (return to LED Off status), reset the control panel (level 2).
[D]	CPU FAULT (yellow)	Indicates that the control panel CPU is not operating properly. The power supply station must be returned to the manufacturer for repair.	Indicates that the CPU has re-initialized (due to control panel shutdown or a fault condition).	Danger: <u>If this LED "blinks", the efficiency of entire system must be checked. To return to LED Off status, reset the control panel (level 2).</u>
[E]	ON (green)	Indicates that the system is operating (On).		This LED will go Off in the event of joint primary (230 V~) and secondary (batteries) power failure.

Installation instructions

7.1 Wall mounting

1. Pull the wires through the wire entry and ensure they do not get in way of operations.
2. Prepare the wall for the four 8mm anchor screws (stop screws) which must be positioned in correspondence with the holes on the backplate of the metal enclosure (*paragraph 5.1 - [J]*).

Danger: Care must be taken not to drill in the vicinity of electrical wiring, heating ducts and plumbing.

Note: Choose anchor screws which are capable of supporting 20kg and which are suitable for the characteristics of the wall.
Ask for professional advice with regard to the best type of anchor screw for the wall concerned.

3. Using the 4 anchor screws, attach the enclosure securely to the wall.

7.2 RS485 BUS wiring

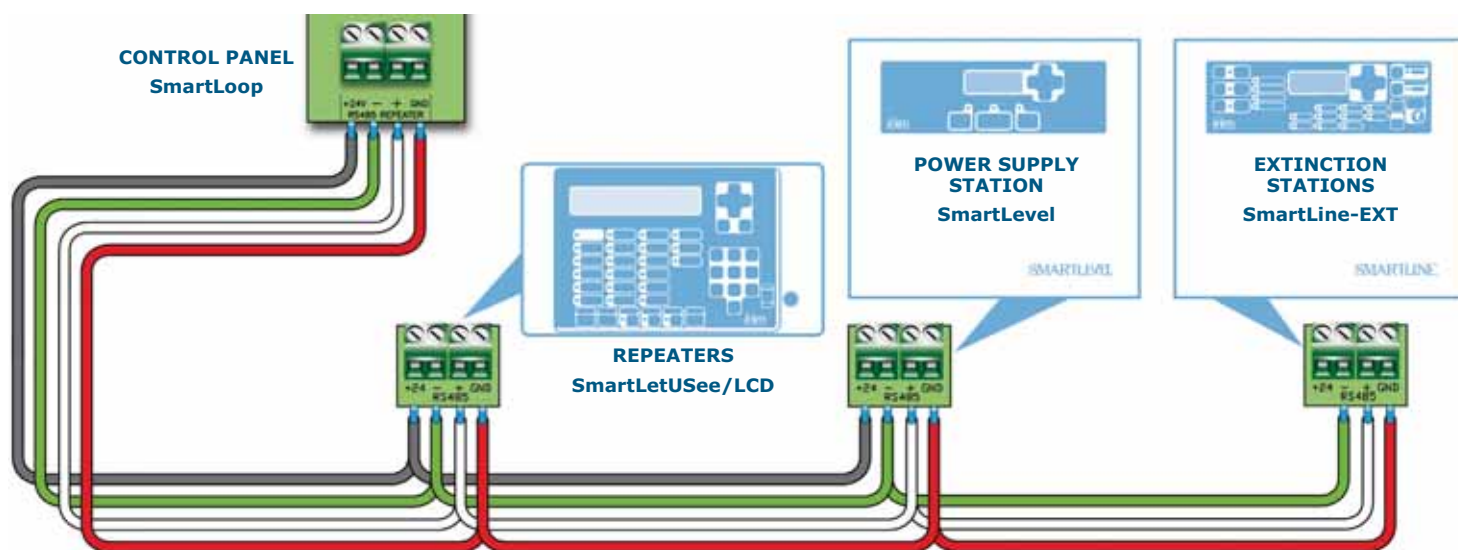

Figure 11 - Connecting the RS485 BUS

1. Use a 4 pole shielded-twisted cable.
2. The cable length between the INIM panel and the SmartLevel power supply station must not exceed 1000m.
3. Connect one end of the cable shield to the control panel earth terminal.

Note: The terminals of the SmartLevel power-supply module are isolated electrically from the RS485 BUS of the fire-detection panel.

In order to allow the fire-detection panel to distinguish between the various SmartLevel power-supply units on the RS485 BUS, you must assign a different address to each. When assigning addresses refer to *paragraph 10.1.3 Addressing the power supply station on the RS485 BUS*.

The end-of-line jumper (JP3) should be in the EOL position only when the power supply station is the last device on the RS485 BUS.

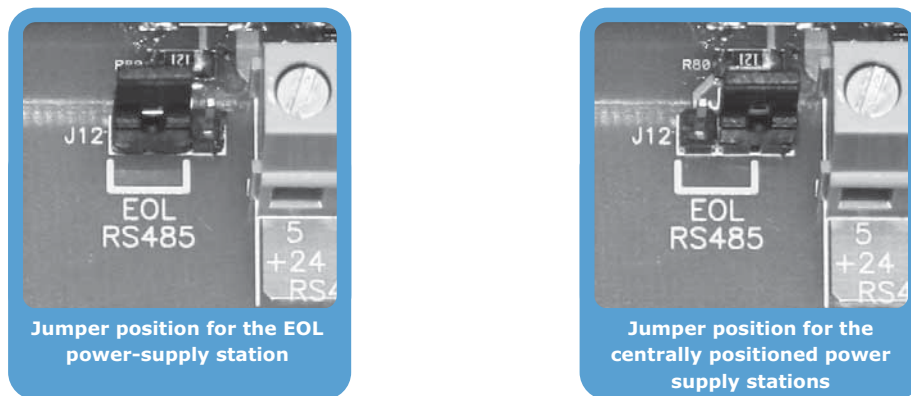

Figure 12 - Jumper position for

7.3 Connecting the output channels

Outputs OUT1-2-3 supply 24V (27.6V \pm 5%) and a maximum current of 1.3A for the SPS24060G model and 3.6A for the SPS24160G model. These outputs can be used to power external devices.

These outputs can be managed via inputs B1, B2, B3 or via the RS485 BUS of an INIM fire-detection panel (refer to *paragraph 4.1 Controlling the Outputs*).

Use NON-shielded cable. The wire section should be compatible with the wire length and load connected to the output.

7.4 Connecting the FAULT output

The FAULT output provides a voltage-free terminal which switches 1A 30V loads. The relay is energized during standby status and closes its common contact to NC. During fault events, the NC contact opens and the common contact closes to NO. The common contact closes to NC only when all fault conditions clear or when the PROG jumper is inserted.

Note: *The relay contacts on the electronic are suitable for SELV circuitry only.*

7.5 Connecting the mains power source

The power system of the SmartLevel stations is EN54-4 compliant.

Danger: **DO NOT power up the system with a non-compliant voltage.**

1. Connect the mains power supply to the terminals on the power-supply module (*Figure 9 - Switching power supply, [A]* and *Figure 13 - Earthing system, [A]*).
For a safety standards compliant system, the Line must be connected to terminal "L", the Neutral conductor to terminal "N".

This station must be connected to a separate line on the Electrical Switchboard (Mains power supply). The line must be protected by a sectioning device which complies with local safety regulations, fire codes, laws and bylaws in force.

Note: *As a further safety measure, the electrical system of the building must be protected against overload and short-circuit.*

Note: *The ends of wires must not be soft soldered in points where they are subject to clamping.*

- Primary power source: 230 V \sim (-15%/+ 10%) 50/60 Hz.
- SPS24060G station current draw: 0.5 A (max.)
- SPS24160G station current draw: 1.1 A (max.)

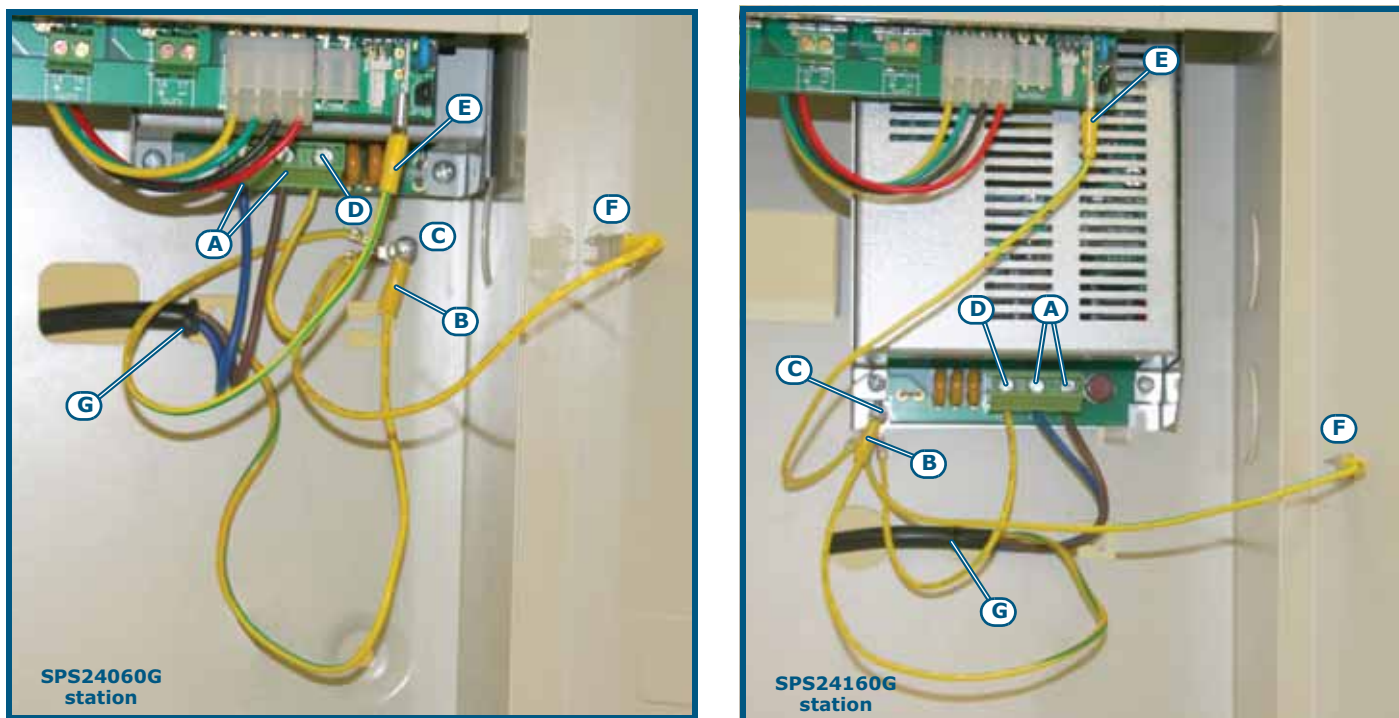

Figure 13 - Earthing system

2. Crimp the earth line wire to the eyelet terminal [B] (included in the package).
3. Attach the wire with the eyelet to the control panel using the ground connection screw [C].
4. Ensure that the terminal "⊕" of the power supply module [D], the motherboard [E] and the frontplate [F] of the enclosure are connected to earthing system.

Danger: **The protective earthing system must be compliant with the local safety regulations, fire codes, laws and bylaws in force.**

Note: *A protective earth connection ensures that all exposed conductive surfaces are at the same electrical potential as the earth surface, in order to avoid the risk of electrical shock if a person touches a device in which an insulation fault has occurred. In the event of an insulation fault, a protective earth connection will generate a high fault current which in turn will trigger an overcurrent protection device (fuse) and disconnect the power supply.*

5. Ensure that low-current safety or signal lines DO NOT come into contact with points with potentially dangerous currents.
Using a plastic cable tie, bunch the wires together and secure them to one of the wire hooks on the backplate of the enclosure [G].

Note: *The connection wires (to the electrical mains, and also any other wires inside the cabinet) must be secured to the cable hooks on the back box by means of plastic cable ties or similar fittings. Use cable with double isolation for the connection to the electrical mains.*

6. Insert the two 12V batteries and connect them to the power supply module (Figure 9 - Switching power supply, [C]).

7.6 Connecting the batteries

The enclosure provides housing for two 12V lead batteries: 7 Ah for the SPS24060G model and 17 Ah for the SPS24160G model. The two batteries must be connected in series, in such way as to provide a 24V⁻⁻⁻ current.

Using the battery connection wire, connect the two batteries together then connect the batteries to the power-supply module using the respective wire (included).

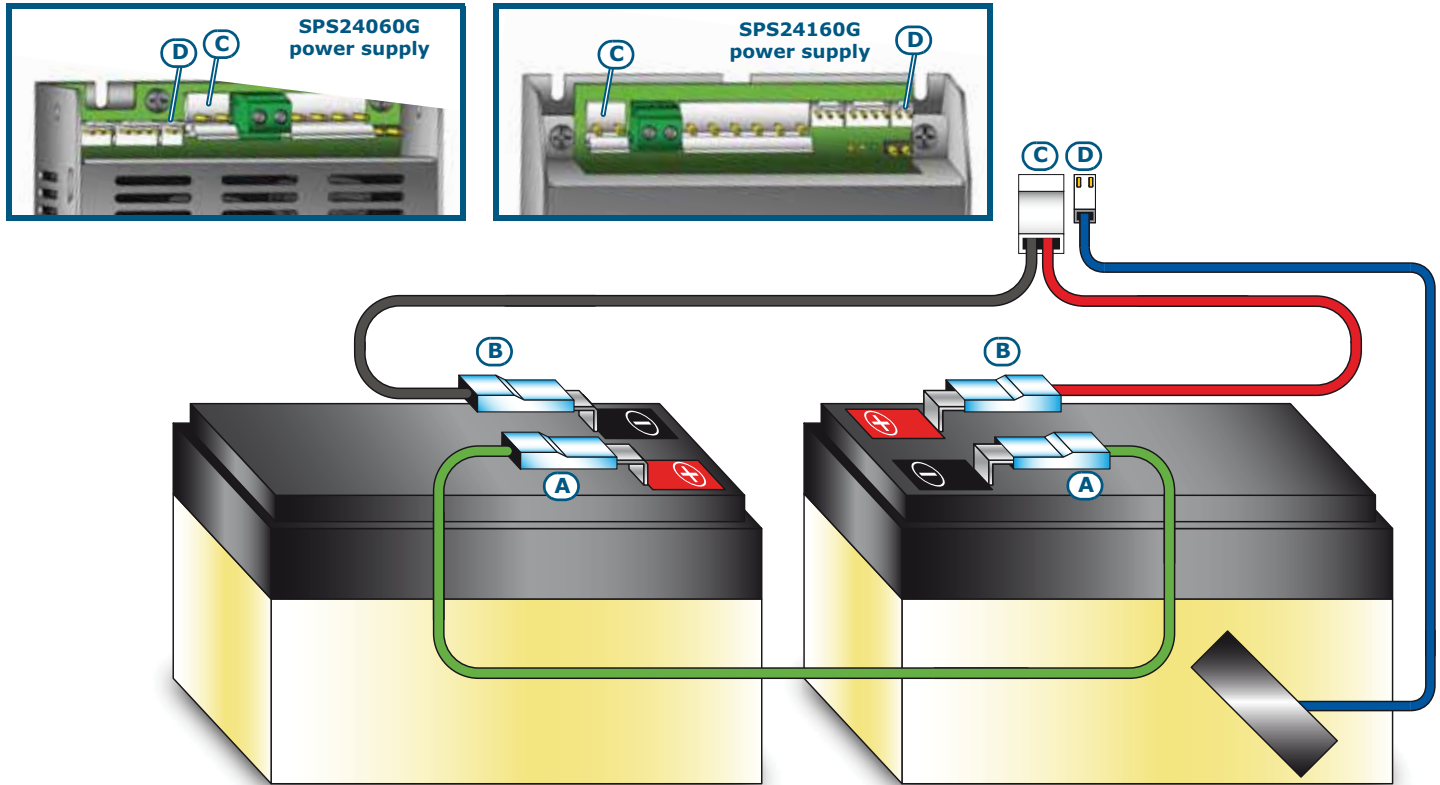

Figure 14 - Connecting the batteries

1. Connect the connection wire [A] to the two batteries.
2. Connect the wire [B] to the batteries.

Attention: Be sure that cable polarity is correct.

3. Connect the terminal [C] of the battery wire to the proper connector of the power-supply unit (*Figure 9 - Switching power supply, [C]*).

Attention: Be sure that connector polarity is correct.

The batteries are the secondary power supply of the system. The power supply station monitors the battery status (efficiency and charge). The battery-test circuit of the power supply station operates as follows:

- Efficiency test
The station tests the battery efficiency every 10 minutes. If their internal resistance is over the allowed limit, the event will be indicated "Batt.fault" on the display, according to the amendment EN54-4:1997/A2.
- Battery level test
The battery-test circuit monitors the battery status (efficiency and charge) continuously. In the event of mains failure, the power supply station will still monitor the battery voltage continuously. If the voltage drops below 22.8V, the power supply station will generate a "Low batt." event. The event will end when the voltage restores to 24.6V.
- Deep discharge shutdown
If a mains failure event lasts for a long period, causing the battery voltage to drop below 18V, the power supply station will shutdown the batteries in order to avoid permanent damage.

7.7 Thermal probe

Attention: **In order to validate the IMQ-SISTEMI DI SICUREZZA certification and comply with EN 54-4 requirements, installation of a thermal probe is essential.**

The thermal probe regulates the charging process in accordance with the battery temperature. The thermal probe protects against battery overheating and consequent permanent damage.

7.7.1 Connecting the thermal probe

Connect the thermal probe to the proper connector of the power-supply module (*Figure 9 - Switching power supply, [D]* and *Figure 14 - Connecting the batteries, [D]*).

Using adhesive-insulating tape, attach the thermal probe to one of the batteries, in order to provide optimized heat-transfer measurements.

Powering up the system

1. Connect the batteries.
The green ON LED will light to indicate that the power supply station is operative.
The CPU LED will blink to indicate that the board is stabilizing.
2. The power supply station will start working after several seconds and the display will show the Language selection screen.

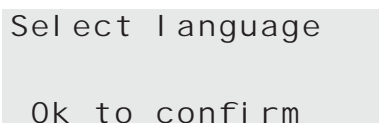

```
Select language
Ok to confirm
```

Figure 15 - Selecting the language.

The CPU LED goes Off.

3. Power up the power supply station from the mains.
If the power supply station is not powered up within two minutes, the display will show the "Mains fail." message and the FAULT LED will go On solid. When the fault clears, the LED will blink to indicate that the fault has been saved to the memory.
4. Check for the presence of faults. If the fault persists, check all wiring sections thoroughly (refer to *Chapter 11 - Troubleshooting*).
5. Clear all fault events.
6. Access the main menu (refer to *Chapter 9 - Viewing the display screens*) and, using the scroll keys, select "Reset station" and press **Ok**.
7. After reset operations, all the LEDs should go Off, with the exception of the green ON LED.
8. The display will show the presentation screen.



```
SMARTLEVEL
SPS24 1.0.0
11/11/2014 08:08
```

Figure 16 - Presentation screen

9. Press **Ok** to view the Main menu. Using the scroll key ▼, select the "Test LEDs" option from the menu. Press and hold **Ok** and ensure that all the LEDs go On.

Viewing the display screens

You can navigate on the display screens using keys ▲, ▼, Ok and Esc.

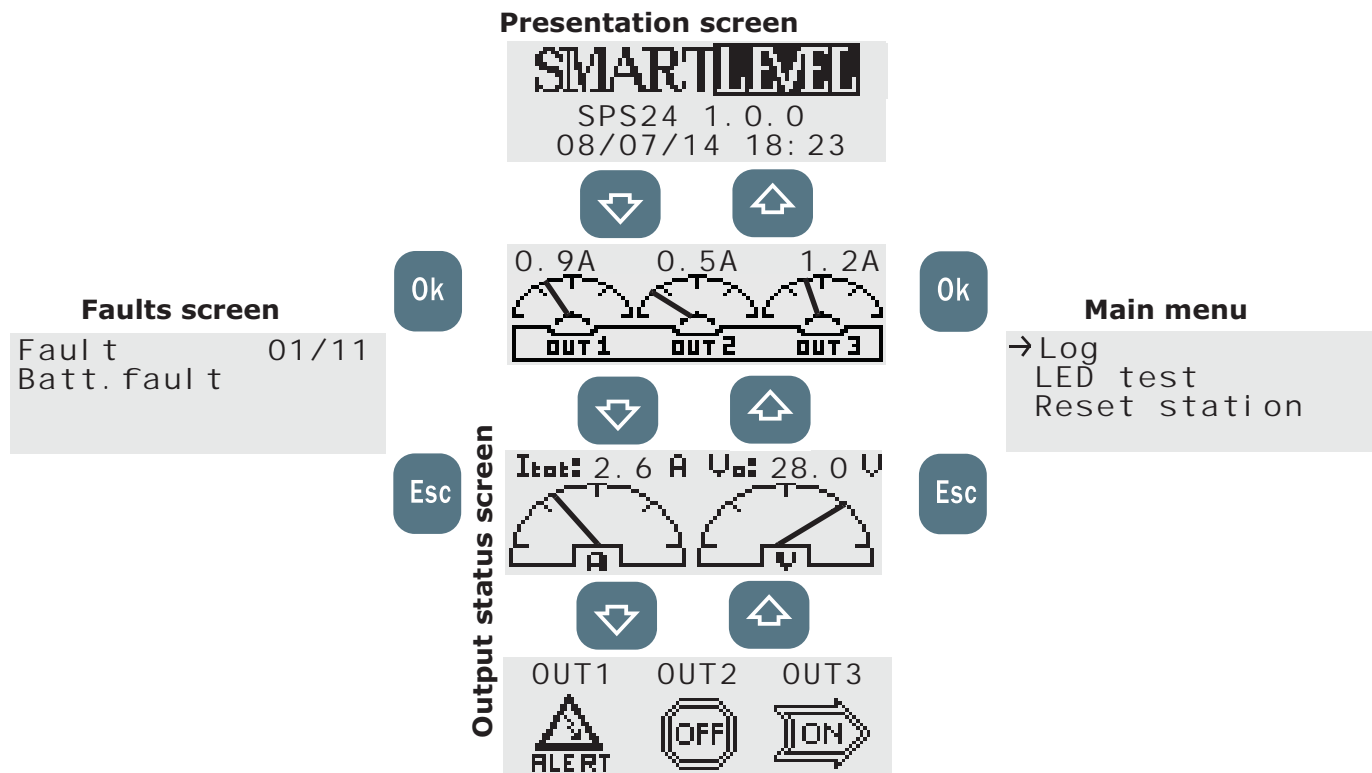

Figure 17 - Navigating on the display screens

9.1 Presentation screen

This screen will appear on first powerup and after every reset operation. It shows the model, firmware version and date and time.

9.2 Output status screen

A series of screens will indicate the status of outputs OUT1, OUT2 and OUT3.

- **Electrical-current value:** indicates the realtime electrical-current value of each output.
- **Electrical-current and voltage values:** indicates the total realtime electrical-current value of the outputs (the sum of the electrical currents of the 3 outputs) and the realtime voltage on the outputs.
- **Output status:** indicates the ON, OFF or Alert status (protection active) of each output.

Output status	Description
ON	24V across the terminals
OFF	0V across the terminals
ALERT	The channel is protected

9.3 Main menu

This menu will allow you to carry out programming/maintenance operations and view the Events log.

9.3.1 Testing the LEDs and buzzer

From station: **Ok, LED test, Ok**

The 3 LEDs on the panel will go On and the buzzer will emit an audible signal for the whole time the **Ok** button is pressed.

9.3.2 Viewing the events log

From station: **Ok, Log, Ok**

All the recorded events (maximum 100) are arranged in chronological order. Use keys ▲ and ▼ to scroll the list.

The log records the following events:

- Reset events (reset power supply station)
- Reset factory settings (restore to default)
- Output status
- Activation/Restoral of all faults events

9.3.3 Resetting the power supply station

From station: **Ok, Reset, Ok**

The power supply station will reset when you press **Ok**.

Note:

The successive options on the Main menu are available only when the PROG jumper is inserted.

9.3.4 Maintenance

From station: **Ok, Maintenance, Ok**

This option will allow you to access the maintenance section (refer to *paragraph 10.1 Programming operations*).

9.3.5 Programming

From station: **Ok, Programming, Ok**

This option will allow you to access the settings section (refer to *paragraph 10.2 Direct Maintenance*).

9.4 Faults screen

This screen lists the current fault conditions of the power supply station (refer to *Chapter 11 - Troubleshooting*).

This screen is active only when fault conditions are present.

Programming and maintenance from the panel

Access to the programming and maintenance sections is allowed only when the PROG jumper is inserted:

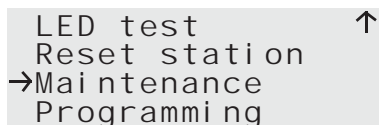

1. Remove the frontplate
2. Insert the PROG jumper.
3. The Main menu provides the "Maintenance" and "Programming" sections.
4. The power supply station is not active. No fault will be signaled.

10.1 Programming operations

From station: **Ok, Programming, Ok**

This sequence will access the programming menu.

10.1.1 Setting up the Booster parameters

From station: **Ok, Programming, Ok, Booster, Ok**

This section will allow you to setup the parameters relating to output channel control.

Standby status	This programming field will allow you to select the standby status of the output (24V or 0V). Press Ok to select the activation method, then press Esc to save the setting and exit.
Standby-ON	When the output is in standby status (refer to the table in <i>paragraph 4.1 Controlling the Outputs</i>) it will be at 24V (activation value = 0V).
Standby-OFF	When the output is in standby status (refer to the table in <i>paragraph 4.1 Controlling the Outputs</i>) it will be at 0V (activation value = 24V).
Activation Time.	Using keys ▲ and ▼↓ this programming field will allow you to select an output and define its activation time (duration). The maximum time is 20 minutes. You can increase the value in steps of 5 seconds using the Ok key. Press Esc to save the setting and exit.

Note: The PROG jumper must be inserted during the entire programming phase.

At default all the outputs are set as "Standby-ON" with an undefined activation time ("--m --s").

10.1.2 Power supply unit options

From station: **Ok, Programming, Ok, Options, Ok**

Navigate through the programming field and set the new values.

Mains failure delay (Delay mainsFail.)	This is a programmable delay (0 to 30 minutes) which runs between the start of the mains failure event and the actual fault signal. This delay avoids unnecessary signaling of brief 'Mains failure' events. Default setting 2 minutes. Use the Ok key to increase this value. Esc to confirm.
Format	You can choose the screen date format. Using keys ▲ and ▼ , select the desired format then press Ok to save the setting and exit. At default the format is dd/mm/yy.
Language	This programming field will allow you to select the desired language. The screen will appear automatically on first startup, that is, if the language has not already been selected. Using keys ▲ and ▼ , select the desired language the press Ok to save the setting and exit.

10.1.3 Addressing the power supply station on the RS485 BUS

From station: **Ok, Programming, Ok, Address RS485, Ok**

This programming section will allow you to assign addresses to all the power-supply stations on the RS485 BUS of the INIM fire detection panel.

Select an address from 01 to 16 (the default address is 01). If more than one SmartLevel power supply station is connected to the RS485 BUS, each must have a different address.

Press **Ok** to assign the desired address. Press **Esc** to save the setting and exit.

10.1.4 Restoring factory settings

From station: **Ok, Programming, Ok, Default data, Ok**

If you select this option, you will access the "Confirm" screen. If you press **OK**, all the settings will reset to default (factory settings).

Parameter	Default value
Mains failure delay	2 minutes
Output activation time (ON Time)	Undefined
Standby status of the outputs	24V
Power Supply unit address on the RS485 BUS	01
Language	You must select the language at first startup

10.2 Direct Maintenance

From station: **Ok, Maintenance, Ok**

This section will allow you to carry out software maintenance using the power supply station interface.

10.2.1 Time and Date

From station: **Ok, Maintenance, Ok, Time and date, Ok**

Using keys **▲** and **▼**, select the desired field then press **Ok** to modify the value.

Press **Esc** to save the setting and exit.

10.2.2 Booster ON/OFF

From station: **Ok, Maintenance, Ok, Booster ON/OFF, Ok**

This section will allow you to modify the output channels directly and view the status of the circuit breakers. Using keys **▲** and **▼**, select the desired output then adjust it to requirements using the **Ok** key.

If the selected output is set as **ON**, it will have a value of 24V. If the selected output is set as **OFF** it will have a value 0V.

If the `In prot.` string appears, it means that the corresponding protection circuit has switched the output Off due to either short-circuit or overload (a charge that exceeds specifications). Under these circumstances, follow the procedure described in *paragraph 11.2 "Output protection" fault*.

10.3 Closing a Programming/Maintenance session

Once all operations are complete, remove the PROG. jumper to end the programming session.

The power supply station will be fully operative and the display will show the presentation screen.

Troubleshooting

Attention: Only authorized operators Level 3 may rectify faults.

11.1 Current faults list

If faults occur, the power-supply station will provide the fault details on the display.

```
Fault 01/06
Batt. fault
```

The first line on the screen shows the chronological order number of the fault over the total number of active faults (the example shows the first of six faults). The line below indicates the type of fault concerned.

Keys ▲ and ▼ will allow you to scroll the faults list.

To access the faults list from the presentation or status screen pressing **Esc**. To exit the faults list and step back to the presentation or status screen press **Ok**.

Note: The list is not available when there are no fault conditions to report.

11.2 "Output protection" fault

```
Fault 01/01
Protec. OUT1
```

This occurs when the power supply station forces the outputs to OFF status (0V) as a means of protection.

Protection status can be triggered by short-circuit or overload (a charge that exceeds specifications) on the output concerned.



There are two ways of restoring this fault, as follows.

• From the Maintenance menu

1. Insert the PROG Jumper.
2. From station: **Ok, Maintenance, Ok, Booster ON/OFF, Ok** the power supply station will reset the Fault LED and the Fault relay.
3. Set the protected output to OFF.
4. Clear the fault on the output circuit in question.
5. Set the protected output to ON and wait until the power supply station restores the output automatically. If the condition persists for more than 10-15 seconds, repeat the operation.
6. When the fault restores, exit the Maintenance menu (remove the PROG jumper).

• Using control inputs

1. Using the inputs (which control the outputs), force the output to OFF (0V) status in order to protect the circuit. In this way, the Fault LED and the Fault relay will remain active.
2. Clear the fault on the output circuit.
3. Re-activate the output via the respective input, or carry out a reset operation (From the station: **Ok, Reset, Ok**). Wait until the power supply station restores the protection status automatically. If the condition persists for more than 10-15 seconds, repeat the operation.
4. When the fault restores, the Fault LED will start to blink to indicate that the fault details have been saved to the memory. To stop the LED from blinking, reset the power-supply station. Re-activation via reset (refer to point 3.) is unnecessary.

11.3 Battery faults

11.3.1 Battery Disconnected or Inefficient

Fault 01/01
Batt. fault

The battery is not connected or has failed the battery efficiency test (EN 54-4:1997 A2 amendment).

1. Allow the batteries to charge for several hours.
2. If the fault signal persists, disconnect the batteries from the station and test them separately.
3. If only one of the batteries has a voltage below 12.5 - 13 V:
 - Replace the faulty battery only.
 - Allow the batteries to charge for several hours.
 - Check that the fault has cleared.
4. If both batteries have a voltage of 12.5 - 13 V, it means they are both inefficient (even though the voltage without load is correct).
 - Replace both batteries.
 - Allow them to charge for several hours.
 - Check that the fault has cleared.

11.3.2 Low Battery

Fault 01/01
Low Batt.

The batteries are running low.

This signal should be present only during primary power source failure (Mains 230 V \sim). Mains power must be restored in order to charge the batteries.

11.4 Other faults

The display shows the message:	Meaning
Mains fail.	Primary power failure (230 V \sim).
Ground fault	Voltage dispersion detected This fault signal can be disabled by disconnecting the respective jumper (<i>paragraph 5.2 - [H]</i>).

Maintenance

The following operations must be carried out regularly.

1. Using a damp lint-free cloth, remove any dust that may have gathered on the control panel (do not use any kind of cleaning product or solvent!).
2. From station, press **Ok, LED test, Ok** to check the proper operating capability of the LEDs and buzzer.
3. Check the battery efficiency and change them if necessary.
4. Check the integrity of all wires and connections.
5. Ensure that there are no extraneous objects inside the control panel.

Note:

Points 1 and 2 can be carried out by authorized persons, whereas all other points must be carried out by qualified technicians.

Appendix A**Order codes**

Following are the order codes of INIM Electronics s.r.l. products:

Code	Description
DCMIINIESPS24G	Installation and programming manual for SPS24060G and SPS24160G power-supply stations
IPS24060G	60W - 27.6V Switching power-supply module
IPS24160G	160W - 27.6V Switching power-supply module
ProbeTH	Thermal probe for battery charge optimization
SPS24060G	60W @ 27.6V SmartLevel power supply station in metal enclosure with 3 controlled outputs, fault relay and connection to RS485 BUS
SPS24060S	60W @ 27.6V SmartLevel power supply station in metal enclosure with 1 controlled output, 2 fault relays and connection to the loop
SPS24160G	160W @ 27.6V SmartLevel power supply station in metal enclosure with 3 controlled outputs, fault relay and connection to RS485 BUS
SPS24160S	160W @ 27.6V SmartLevel power supply station in metal enclosure with 1 controlled output, 2 fault relays and connection to the loop

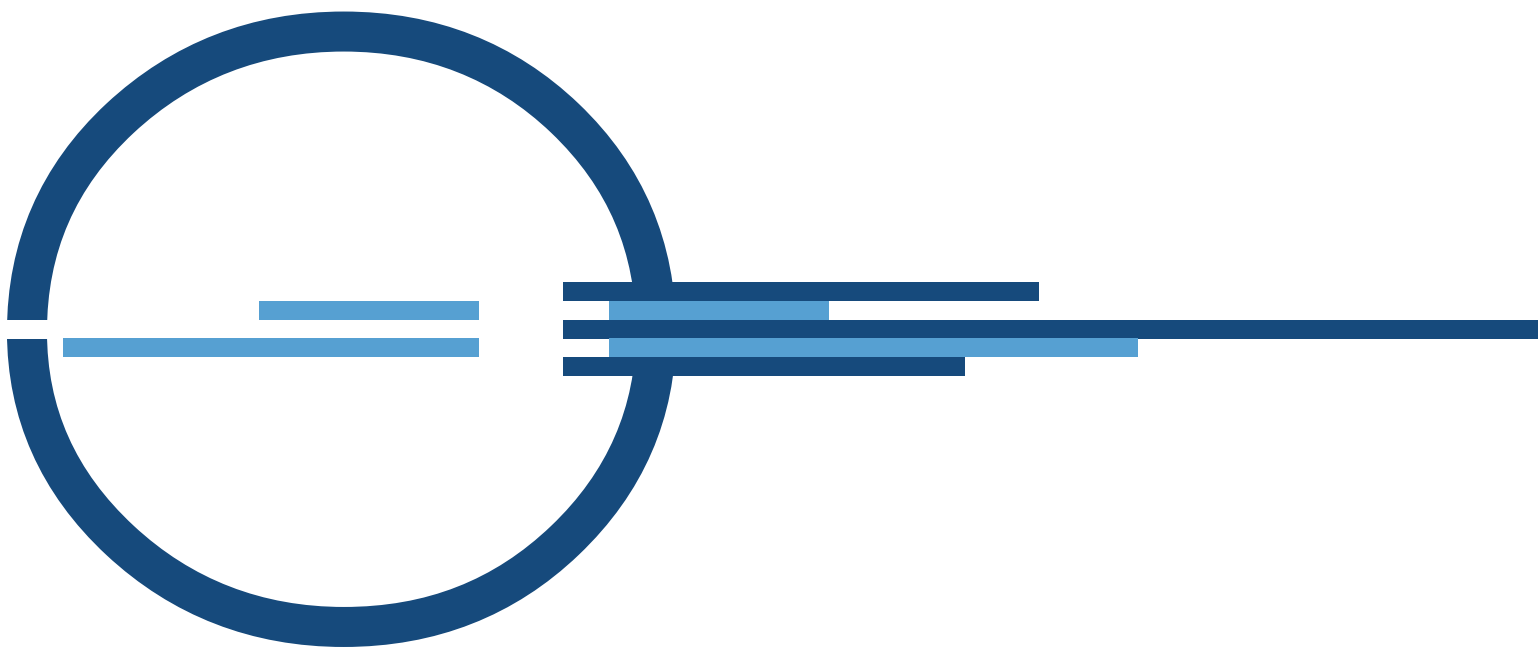

ISO 9001 Quality Management
certified by BSI with certificate number FM530352

via Fosso Antico snc - fraz. Centobuchi
63076 Montepandone (AP) ITALY
Tel. +39 0735 705007 _ Fax +39 0735 704912

info@inim.biz _ www.inim.biz